

SPECIFICATION

		APV		APV ARENA		APV NEW LUXURY	
		GE	GL	GX-MT	SGX-MT	MT	MT
DIMENSIONS							
Overall length	(mm)	4230	4230	4155	4155	4300	4300
Overall width	(mm)	1655	1655	1655	1655	1690	1690
Overall height	(mm)	1865	1865	1865	1865	1855	1855
Wheelbase	(mm)	2625	2625	2625	2625	2625	2625
Tread	Front (mm)	1435	1435	1425	1425	1435	1435
	Rear (mm)	1435	1435	1425	1425	1435	1435
Minimum ground clearance	(mm)	180	180	175	175	175 (diff)	175 (diff)
Minimum turning radius	(m)	4,9	4,9	5,4	5,4		
WEIGHTS							
Curb weight	(kg)	1250		1250-1320		1250-1320	
Gross vehicle weight	(kg)	1950		1950		1950	
CAPACITIES							
Seating capacity	(persons)	8	8	7		7	
Fuel Tank Capacity	(liters)	46		46		46	
ENGINES							
Type		G15A		G15A		G15A	
Number of cylinders		4 in line		4 in line		4 in line	
Number of valves		16		16		16	
Piston Displacement	(cc)	1493		1493		1493	
Bore x stroke	(mm)	75,0 x 84,5		75,0 x 84,5		75,0 x 84,5	
Compression ratio	(mm x mm)	9,5 : 1		9,5 : 1		9,5 : 1	
Maximum output	(PS/rpm)	92,4/6000		92,4/6000		92,4/6000	
Maximum torque	(N.m/rpm)	126/3000		126/3000		126/3000	
Fuel system		Multi Point Injection		Multi Point Injection		Multi Point Injection	
TRANSMISSIONS							
Type		5-speed Manual		5-speed MT		5-speed Manual	
Gear ratios	1st	4,545		4,545		4,545	
	2nd	2,628		2,628		2,628	
	3rd	1,865		1,865		1,865	
	4th	1,241		1,241		1,241	
	5th	1,000		1,000		1,000	
	Rev	4,431		4,431		4,431	
	Final	4,300		4,300		4,300	
STEERING							
Type		Rack & Pinion (Power Steering)		Rack & Pinion (Power steering)		Rack & Pinion (Power Steering)	
SUSPENSIONS							
Front		Mac Pherson Strut & Coil Springs		Mac Pherson Strut & Coil Springs		Mac Pherson Strut & Coil Springs	
Rear		Leaf Rigid Axle		3-link rigid axle with coil springs		3-link rigid axle with coil springs	
BRAKES							
Front		Ventilated Discs		Ventilated Discs		Ventilated Discs	
Rear		Leading & Trailing Drums		Leading & Trailing Drums		Leading & Trailing Drums	
TYRES & WHEELS							
Tyres (Front & Rear)		185/80 R14	185/80 R14	195/65 R15		195/65 R15 or 215/50 R17	
Alloy Wheels		14"	14"	15"		15" or 17"	
SAFETY AND SECURITY							
Seatbelts 3-point ELR	Front	✓		With Height Adjusters		With Height Adjusters	
	2nd row	✓		✓		✓	
	3rd row	✓		✓		✓	
Side Impact Beam		✓		✓		✓	
Keyless entry		-		✓		✓	
Air Intake (cm)		101		101		101	

Standard and optional equipment available may vary for individual markets. Please enquire at your dealers, as specifications and illustrations may refer to models not available in your region. PT. Suzuki Indomobil Sales reserves the right to change, without prior notice, prices, colours, materials, equipment, specifications and models, and also to discontinue models.

DIMENSION

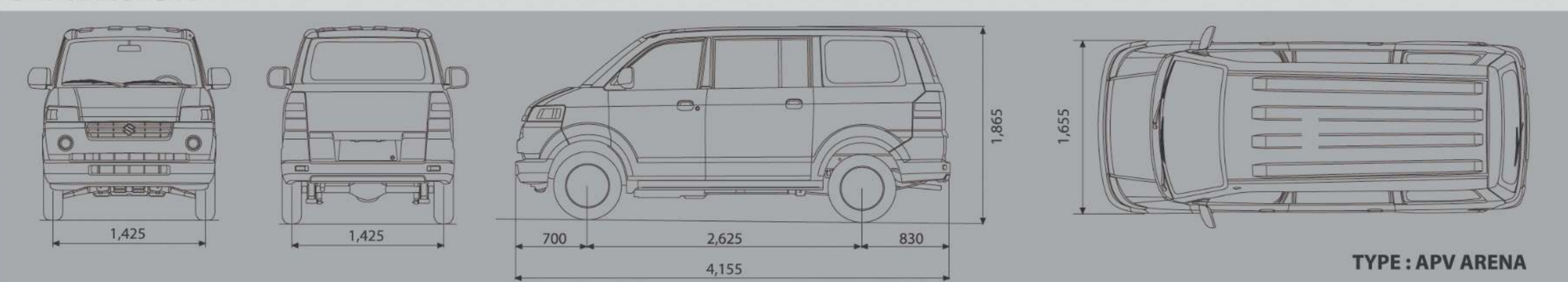

YOUR GEAR



BISA SEMUA, SEMUA BISA!

PERFORMA YANG LEBIH TANGGUH

Mesin Tipe G15A Berkapasitas 1500 cc. Lebih Bertenaga di Tanjakan dan Irit Bahan Bakar.



Transmisi Manual
Dengan 5 percepatan, lebih gesit dan lincah.

LEBIH AMAN

Memberikan berbagai macam fitur keamanan yang berkualitas, membuat Anda berkendara dengan Suzuki APV lebih aman.



AIR INTAKE TINGGI
Jarak Air intake setinggi 101 cm dari ground lebih aman saat melintas genangan air.



TECT BODY
Teknologi yang dapat meredam energi benturan sehingga meningkatkan keamanan saat terjadi kecelakaan.



SIDE IMPACT BEAM
Melindungi pengendara saat terjadi benturan dari samping kendaraan.

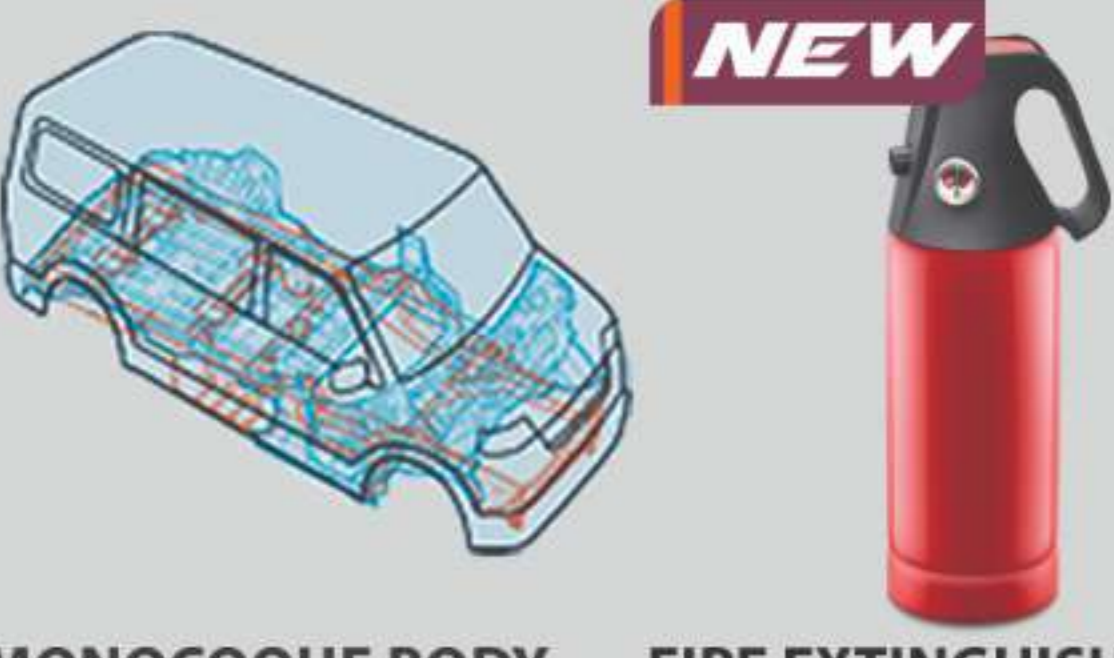

FIRE EXTINGUISHER
Fitur keselamatan semakin lengkap dengan tersedianya alat pemadam api ringan.

LEBIH NYAMAN

Interior yang elegan dan berkelas dengan berbagai fitur yang memberikan kemudahan.



POWER STEERING
* GL, GX, SGX, LUXURY



POWER WINDOW
* GL, GX, SGX, LUXURY



DOOR TRIM CONSOLE
* GL, GX, SGX, LUXURY



AC DOUBLE BLOWER
* GX, SGX, LUXURY



REAR SUSPENSION WITH COIL SPRING
* GL, GX, SGX, LUXURY



SPEEDOMETER
* GL, GX, SGX, LUXURY

LEBIH BESAR MANFAATNYA

Apapun bisa Anda lakukan, mulai dari menyenangkan istri berbelanja, memanjakan anak-anak ketempat rekreasi, liburan bersama keluarga besar hingga mengembangkan bisnis dan usaha. Berkendara pun terasa lebih nyaman dan aman karena keunggulan Mid Engine-nya yang memberikan keseimbangan pada laju kendaraan.



Captain Seat mewah yang dapat menghadirkan kenyamanan selama perjalanan.



Chrome Grille yang gagah dan mewah.



Fog Lamp yang menambah visibilitas pengendara.



Chrome Side Mirror dengan tampilan Stylish with Electric Mirror.



Chrome Door Handle yang kontras.



2 Din Audio, menambah kenyamanan dan keceriaan keluarga.



Suzuki APV memiliki ruang yang lega, lengkap dengan fitur yang modern, menghadirkan keleluasaan, kemewahan dan kenyamanan.



Tempat duduk untuk 8 orang, dilengkapi dengan arm rest, lebih nyaman dalam perjalanan.



Chrome Grille gagah dan modern.



Fog Lamp yang menambah visibilitas pengendara.



Body Color Side Mirror with Electric Mirror yang senada dengan warna body.



Body Color Door Handle, terlihat serasi dengan warna body.



Suzuki APV GX dengan kapasitas 8 penumpang memberikan rasa nyaman dan lega saat berkendara.



Tempat duduk untuk 8 orang, lebih lega dan lebih nyaman dalam perjalanan.



Chrome Grille yang gagah.



Black Side Mirror yang modern.



Black Door Handle, tampil serasi dengan Side Mirror.



1 Din Audio, menambah kenyamanan berkendara.



Ruang yang luas dan multifungsi dengan kenyamanan untuk 8 penumpang.

APV NEW LUXURY

BERAGAM KELEBIHAN ISTIMEWA

APV NEW LUXURY KINI HADIR DI TENGAH-TENGAH KELUARGA INDONESIA DENGAN MENGUSUNG FITUR - FITUR TERBARU LENGKAP DENGAN TEKNOLOGI CANGGIH YANG BERBALUT DENGAN KEMEWAHAN.



Captain Seat with Eco Leather
Captain seat pada barisan tengah serta seluruh seats dilapisi kulit berkualitas yang menambah kenyamanan penuh kemewahan.



Luxurious Cabin
Atur mewah dan berkelas yang kental terasa dengan adanya fitur-fitur dengan teknologi terkini serta penggunaan material yang berkualitas.



Wooden Panel Dashboard
Tampilan baru yang berkelas hadir melalui wooden panel pada bagian dashboard.



New Elegant Front Chrome Grill
Tampak kokoh dan menawan, memperkuat karakter dan karisma APV New Luxury.



Chrome Outside Mirror with Double Folding
Menghadirkan kesan mewah dan lebih modern.



Chrome Fog Lamp with Daytime Running Light (DRL)
Fog lamp dengan aksesoris chrome juga dilengkapi DRL yang menambah visibilitas pengendara.



New Design Alloy Wheel R17
Lebih gagah dan mewah dengan ukuran baru dan desain baru.



New Inside Mirror with Monitor Rear Camera
Sebuah teknologi terkini yang memberi kemudahan saat parkir.

TYPE GE | POWER STEERING

Ekonomis Nyaman untuk Keluarga

Performa mesin yang responsive memberikan keuntungan berlipat. Design interior yang praktis tetap nyaman untuk bisnis dan kebutuhan keluarga.



Seat Belt
Suzuki APV memiliki tingkat keamanan yang prima, sabuk pengaman di bangku baris pertama dan kedua memberi jaminan keamanan sempurna.



1 Din Audio
Perjalanan menjadi lebih menyenangkan diiringi musik favorit keluarga.



Foot Step
Memberikan kemudahan bagi seluruh anggota keluarga saat memasuki kendaraan.



Lipatan bangku ke 1 | Lipatan bangku ke 2 | Lipatan bangku ke 3



Ruang kabin luas dan nyaman untuk 8 orang penumpang serta dapat menampung beragam barang bawaan, sehingga menambah keceriaan keluarga.



04/2021

